

Инструкция по сборке

Ромео

Шкаф угловой - 2

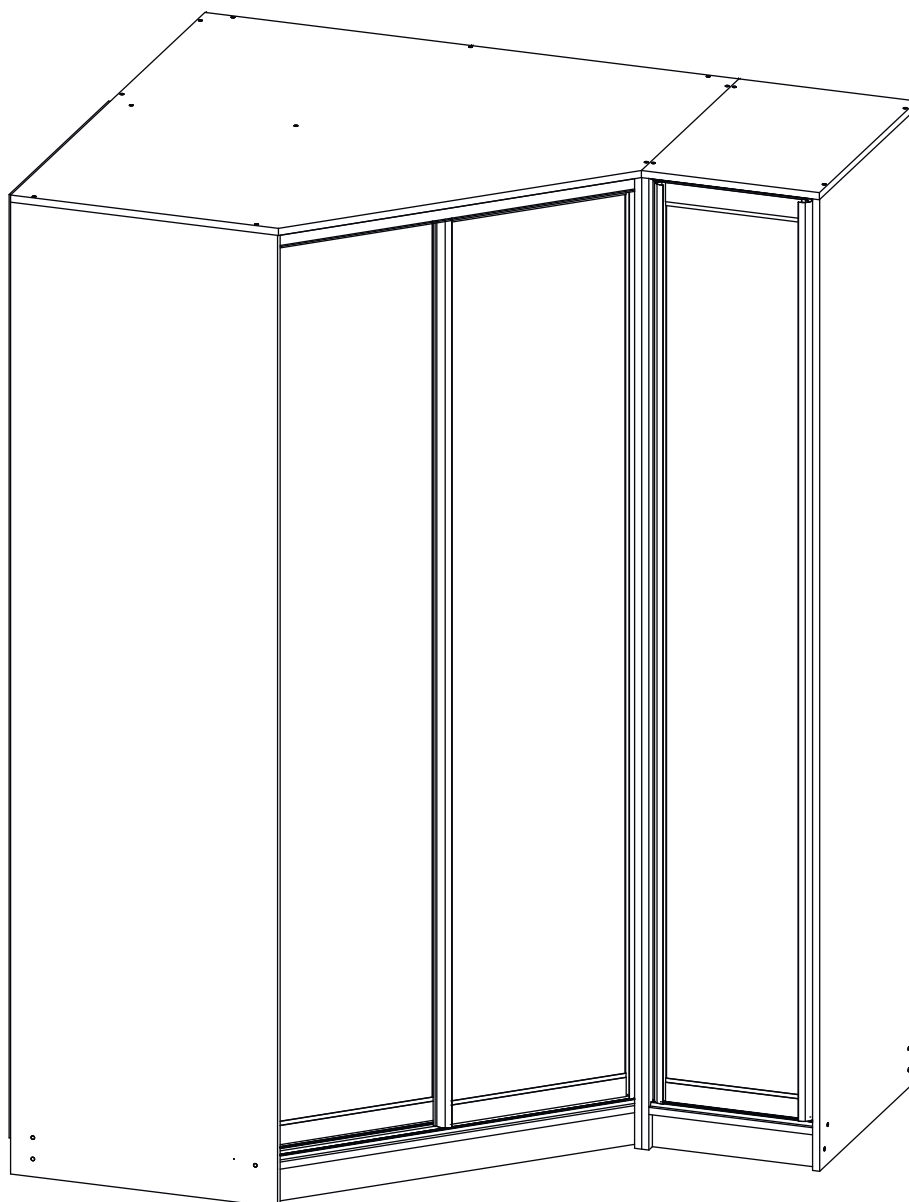

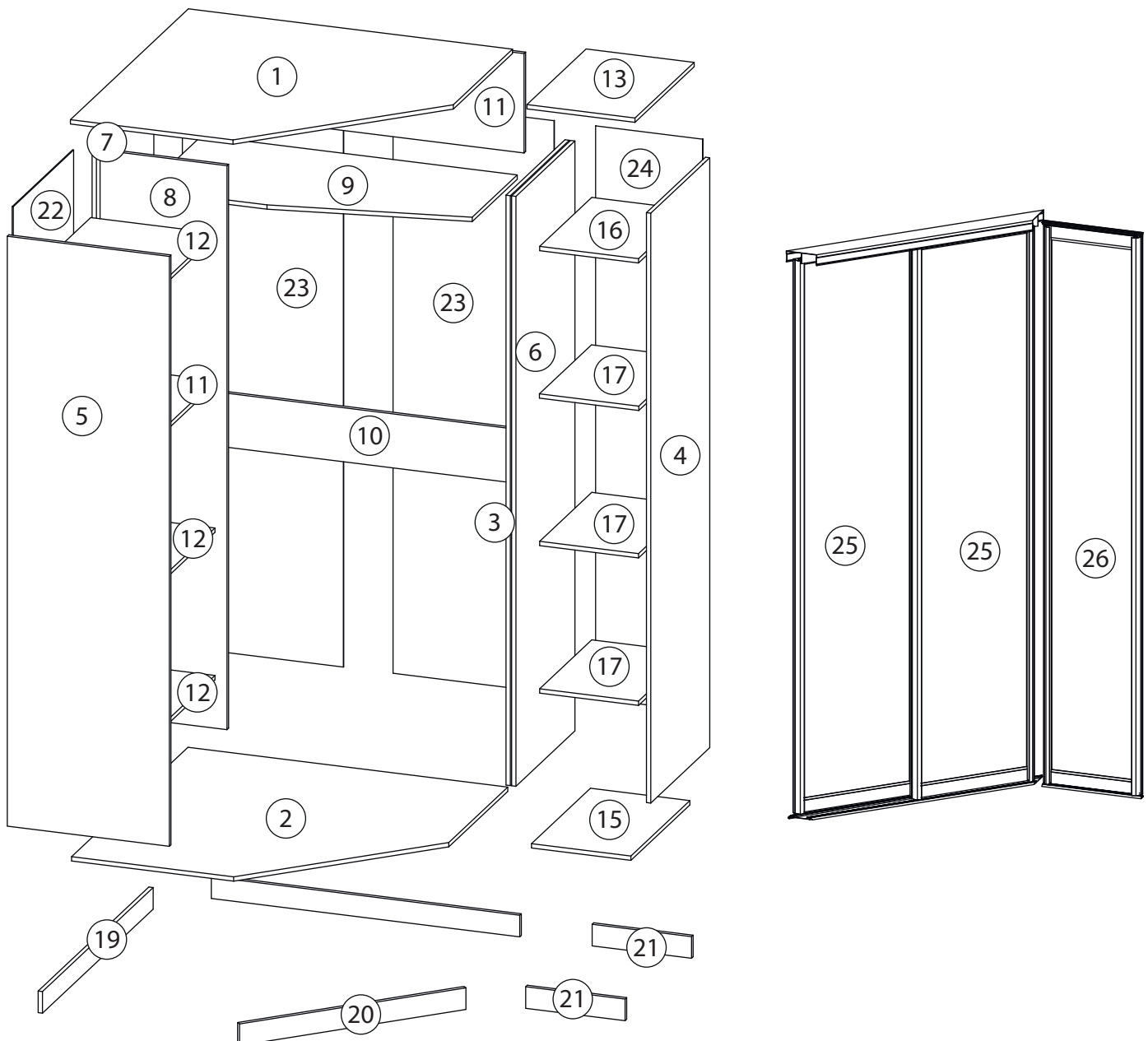

Детали

Поз.	Наименование	Кол-во	Длина	Ширина	Поз.	Наименование	Кол-во	Длина	Ширина
1	Крыша	1	1200	1200	14	ребро жёсткости	1	1168	200
2	Дно	1	1184	1184	15	Дно	1	368	600
3	Бок правый	1	2184	600	16	Горизонтальная1	1	368	530
4	Бок правый	1	2184	600	17	Полка	3	366	530
5	Бок левый	1	2184	600	18	Цоколь	1	1142	80
6	Бок левый	1	2184	600	19	Цоколь	1	1126	80
7	Щит задний	1	2088	584	20	Цоколь	1	869	80
8	Перегородка	1	2088	470	21	Цоколь	2	368	80
9	Горизонтальная1	1	584	1168	22	Задняя стенка ЛХДФ	1	2120	614
10	ребро жёсткости	1	368	1168	23	Задняя стенка ЛХДФ	2	2120	596
11	Горизонтальная2	1	584	460	24	Задняя стенка ЛХДФ	1	2120	396
12	Полка	3	582	460	25	Фасад	2	1986	429
13	Крыша	1	400	602	26	Фасад	1	1975	320

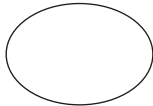
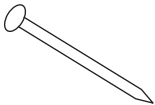
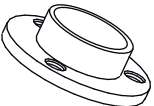
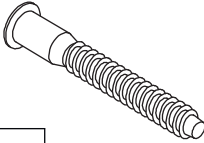
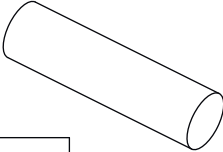

Фурнитура

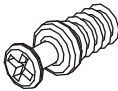
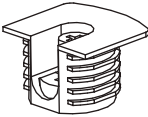
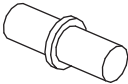
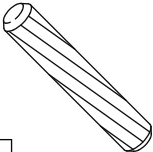
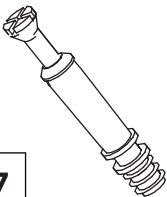
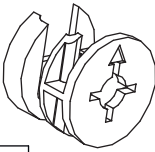
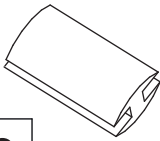
 27	 28	 29	 30	 31
<u>Заглушка</u> $\varnothing 13$	<u>Гвоздь 1,6x25</u>	<u>Штангодержатель</u>	<u>Евровинт 7x50</u>	<u>Штанга</u>
 32	 33	 34	 35	 36
<u>Саморез 3,5x16</u>	<u>Винт для стяжки</u> <u>VB35</u>	<u>Стяжка VB35</u>	<u>Полкодержатель</u>	<u>Шкант бук</u>
 37	 38	 39		
<u>Шток эксцентрика</u>	<u>Эксцентрик</u>	<u>Профиль для ДВП</u>		

1

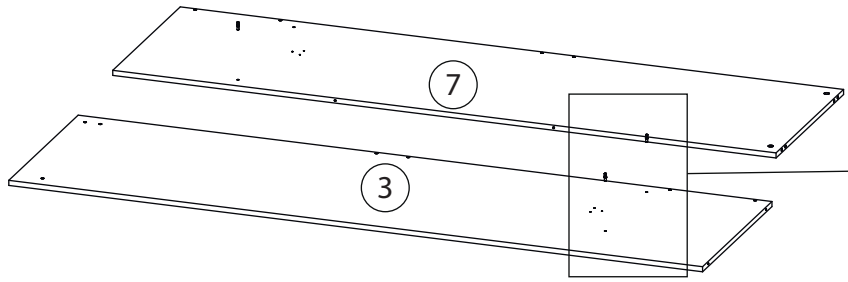

Бок левый (5)
собирается аналогично

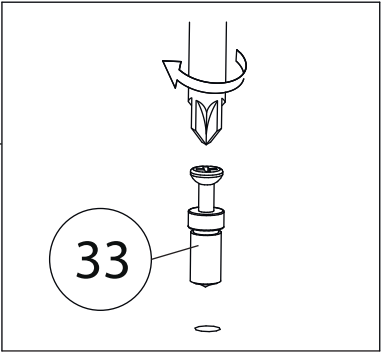

2

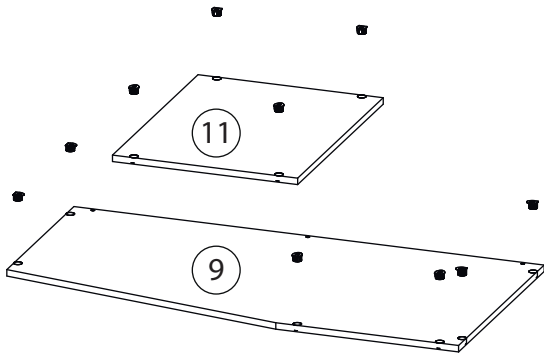

3

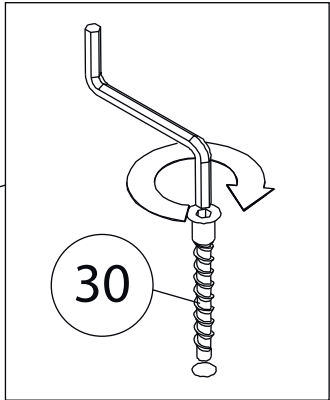
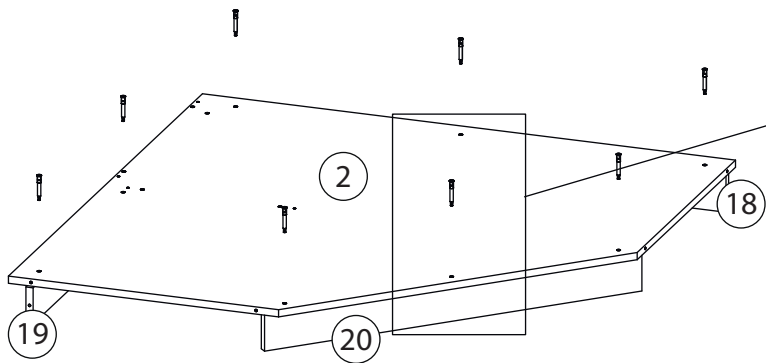

4

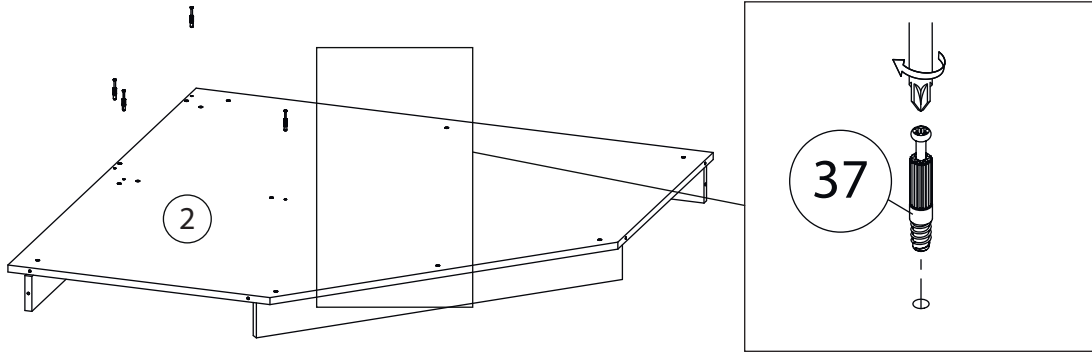

5

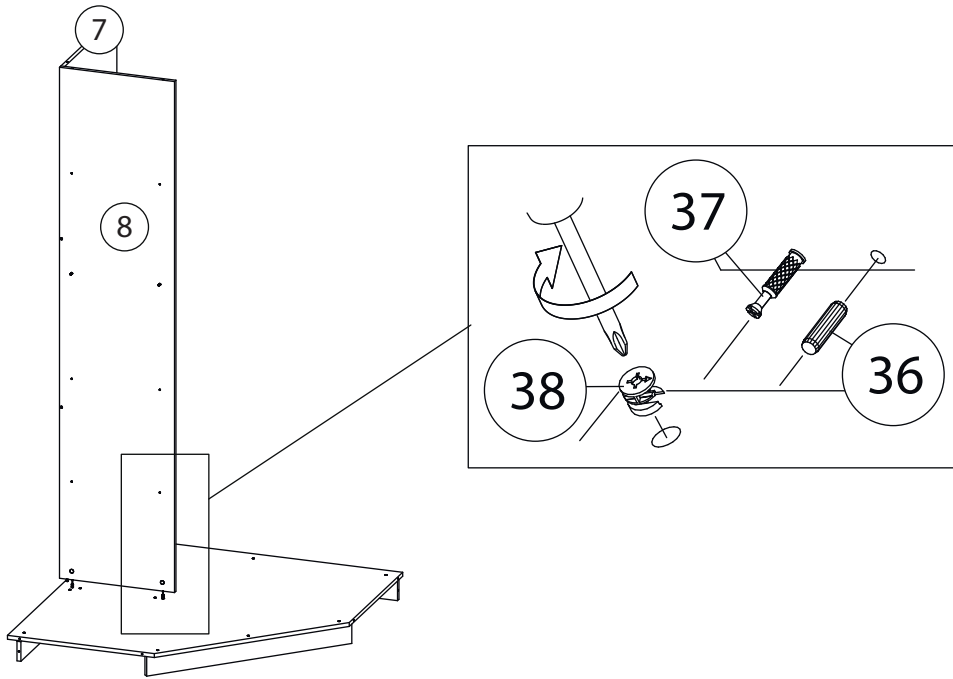

6

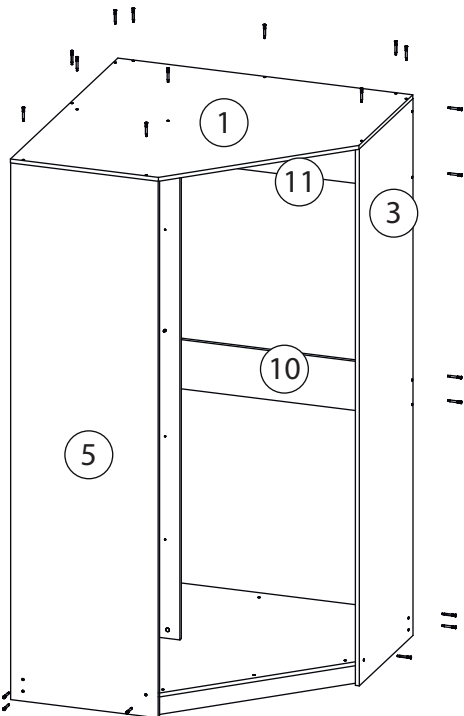

7

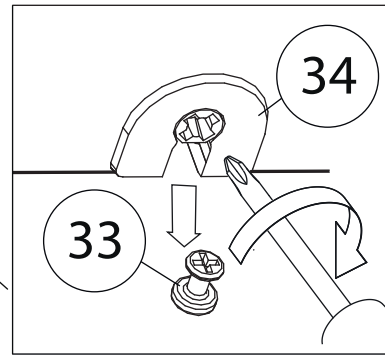
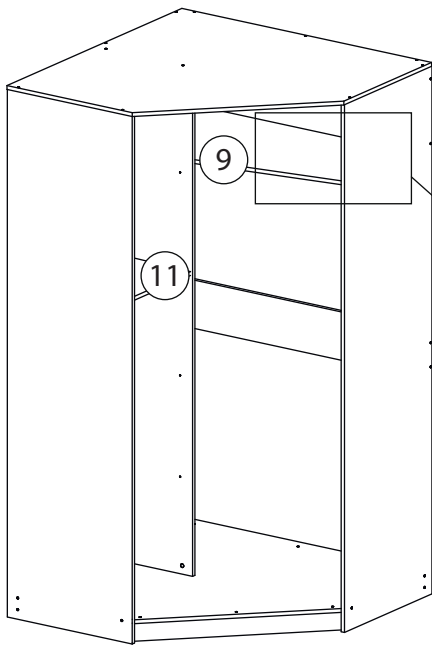

8

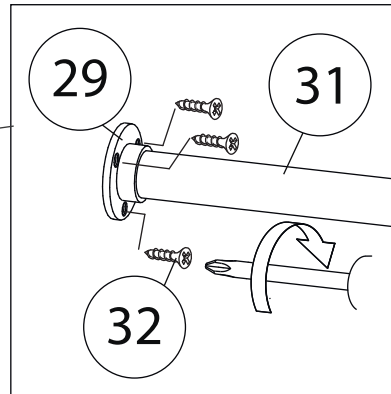
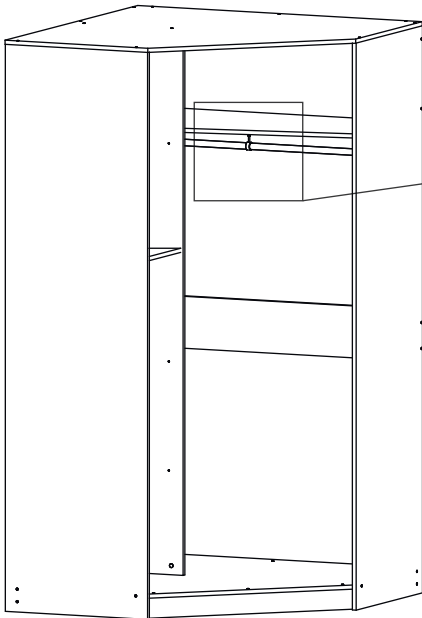

9

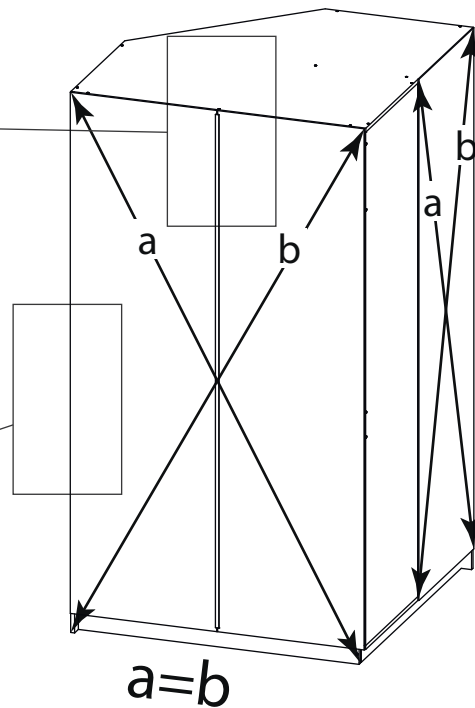
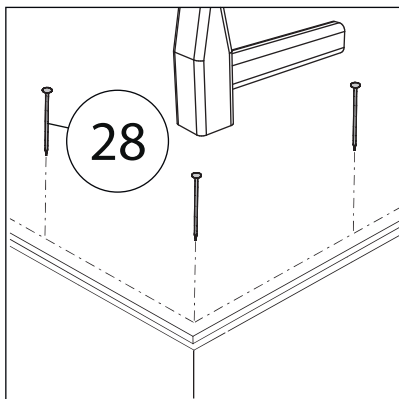
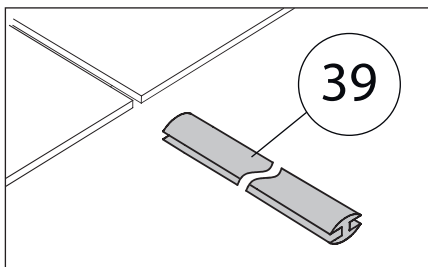

10

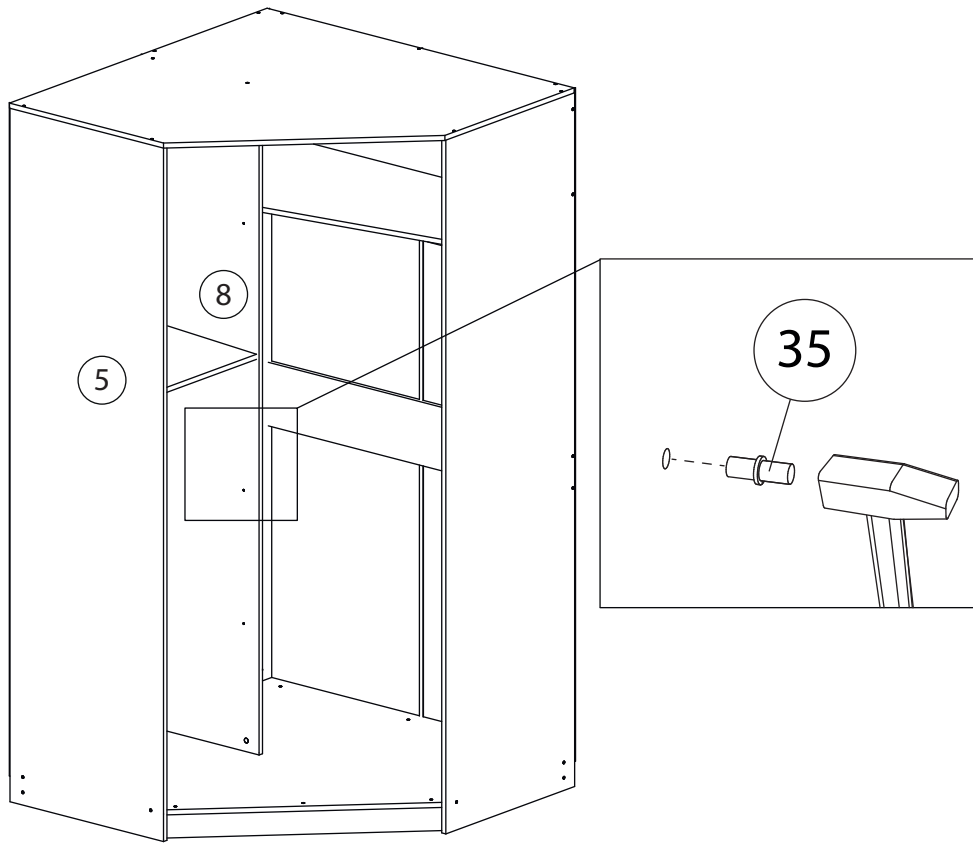

11

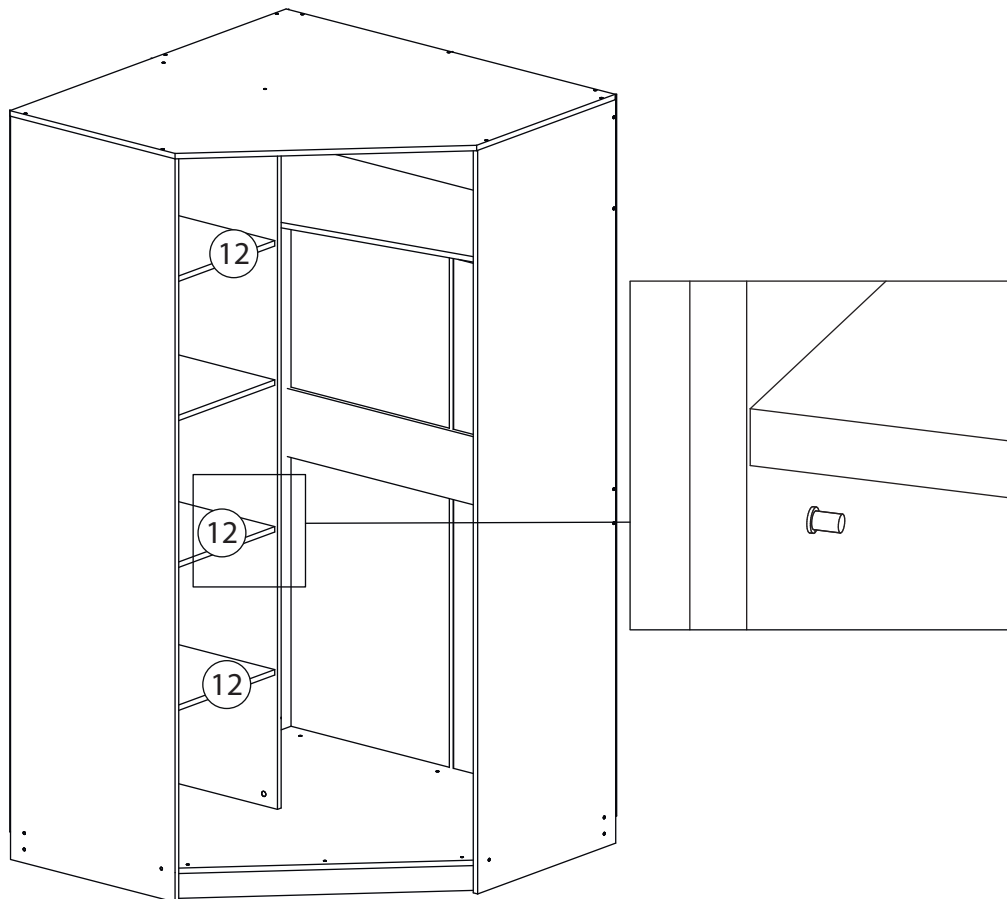

12

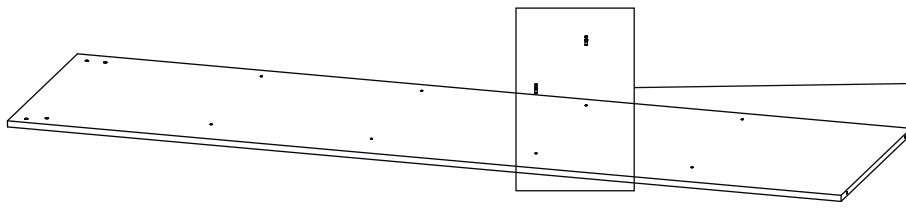

Бок левый (6)
собирается аналогично

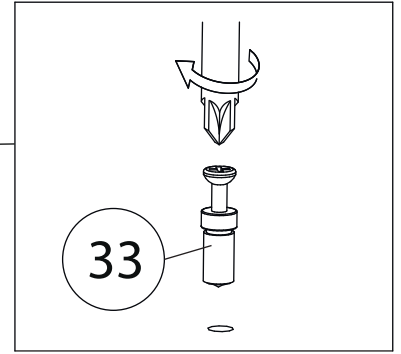

13

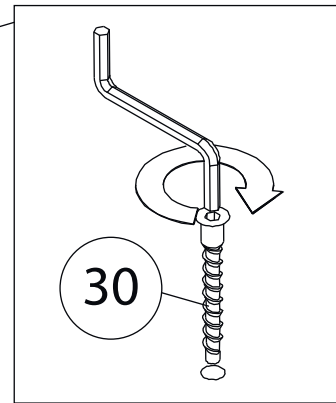
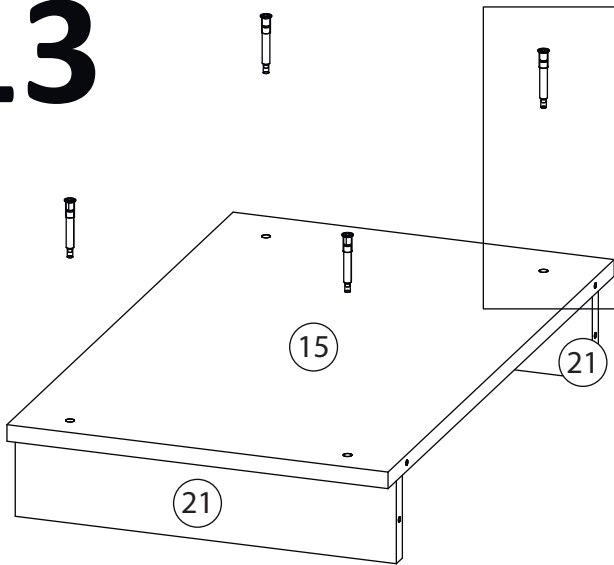

14

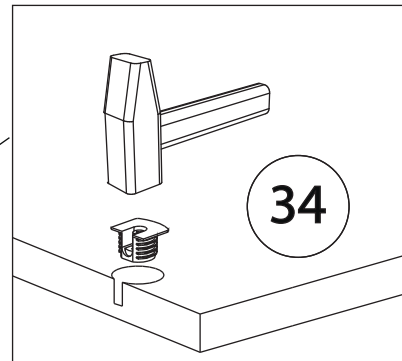
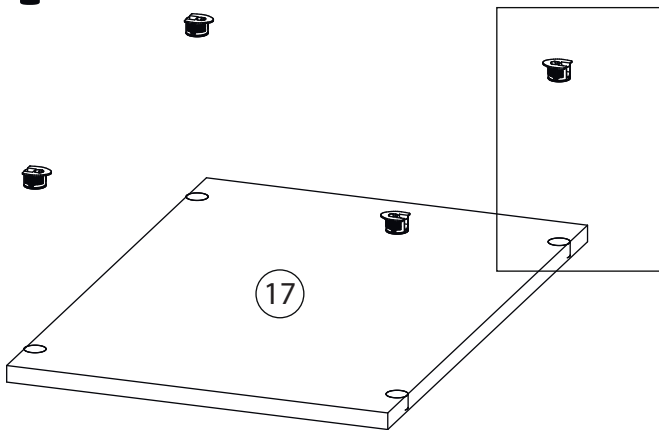

15

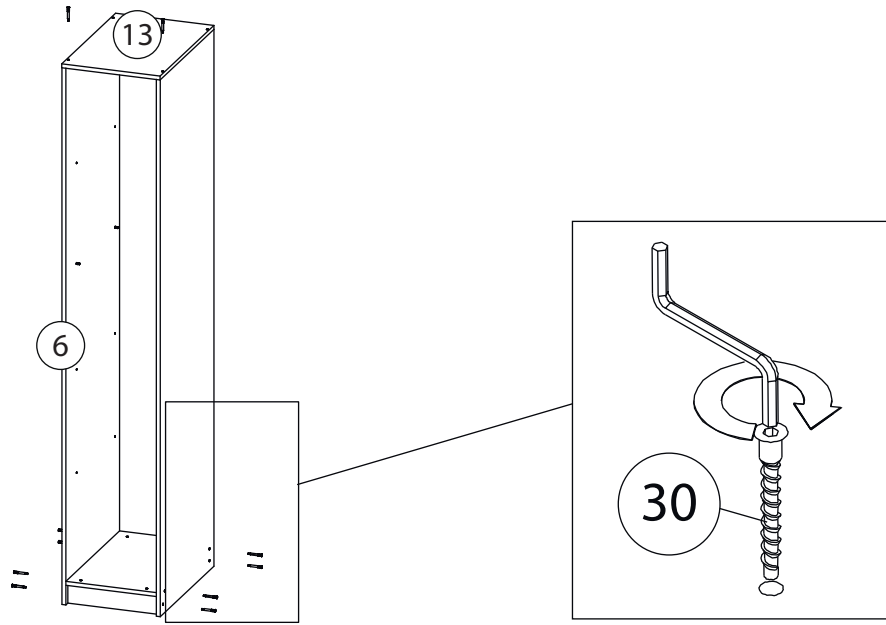

16

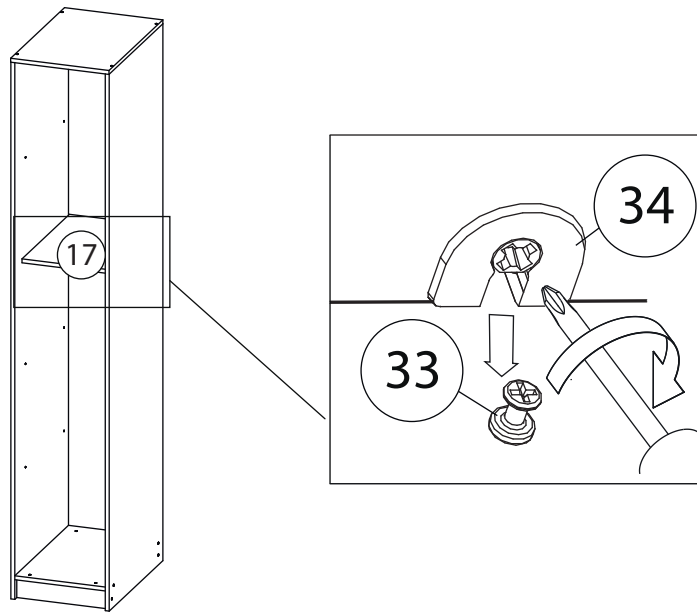

17

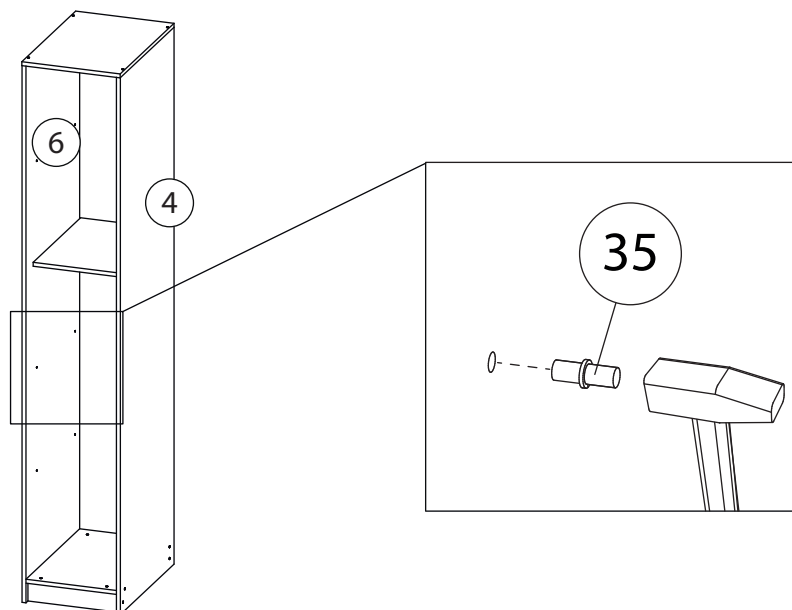

18

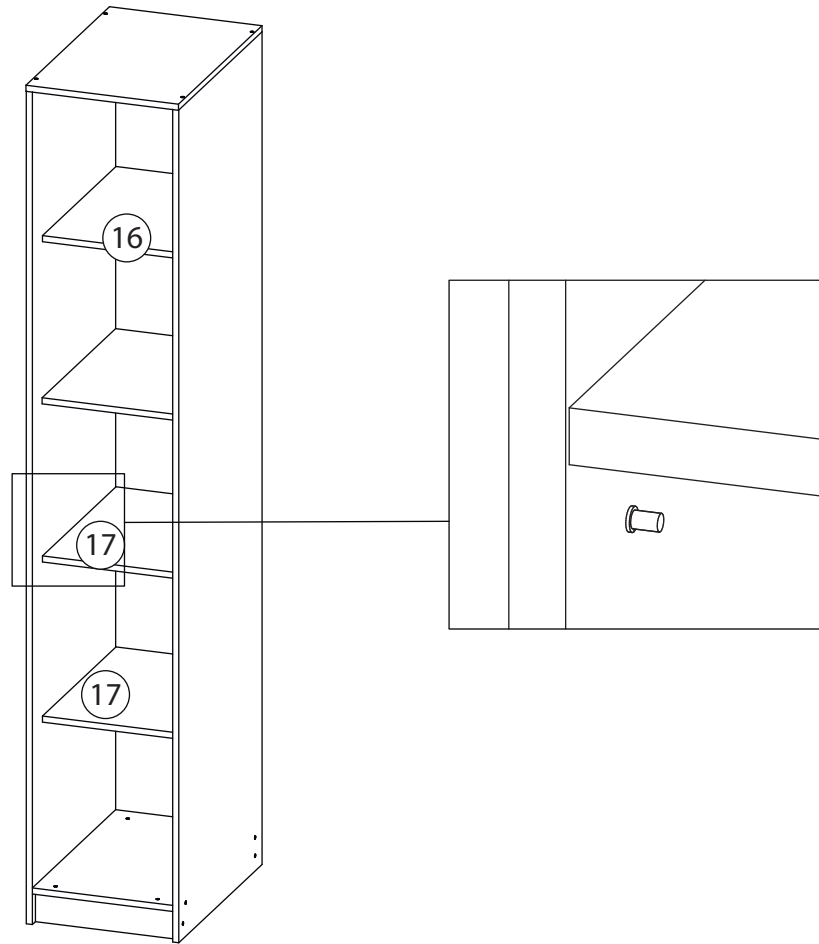

19

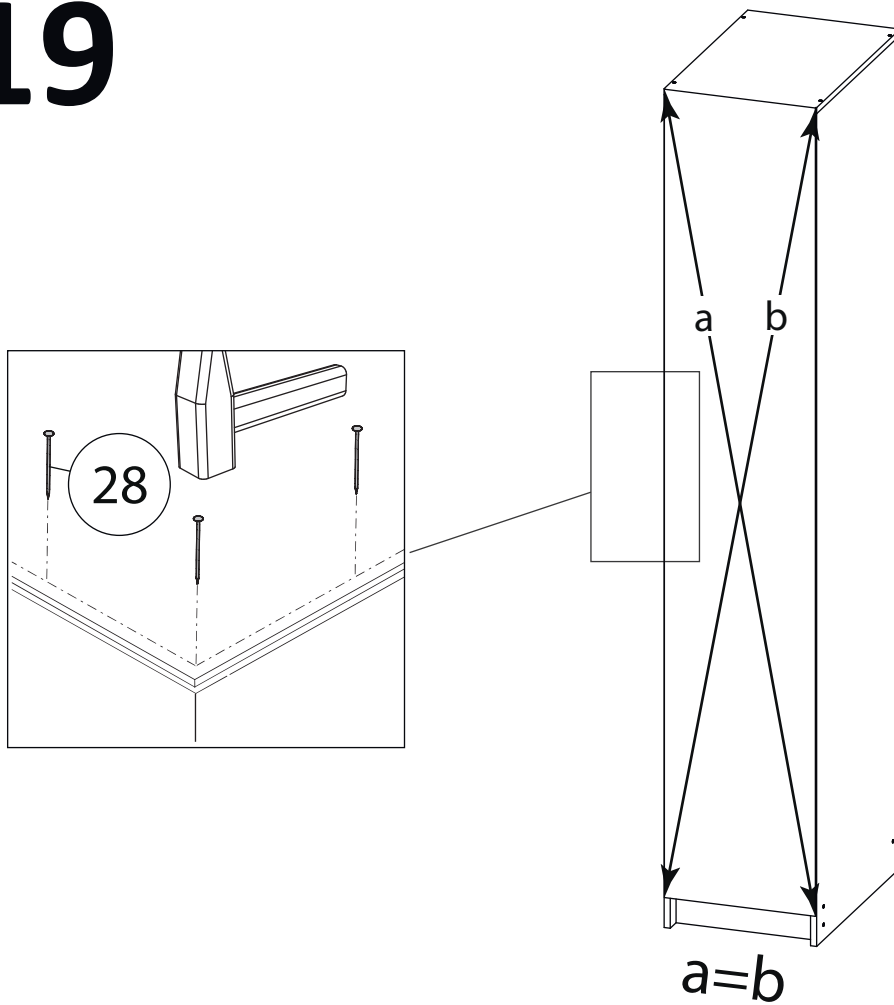

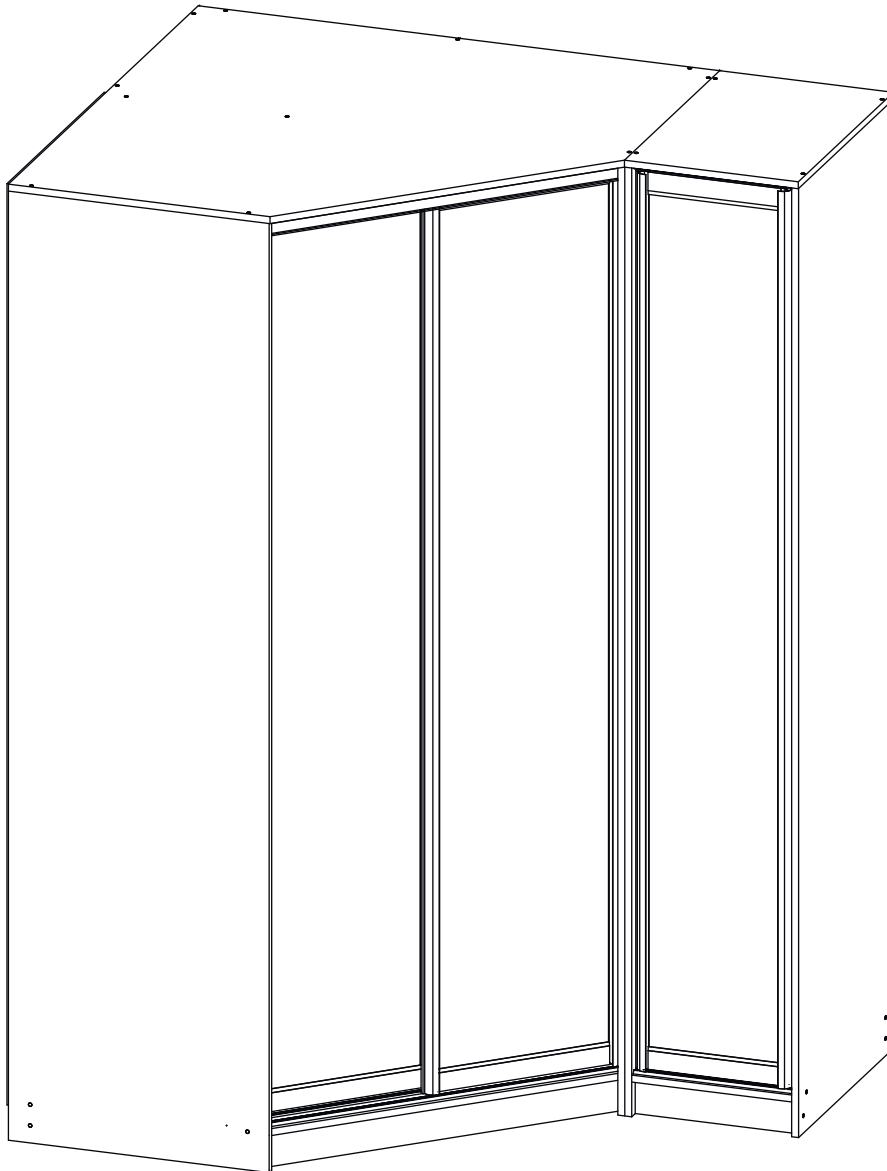

Заклеить технические отверстия заглушками.