

Инструкция по сборке

Астрис

Шкаф распашной с зеркалом - 3

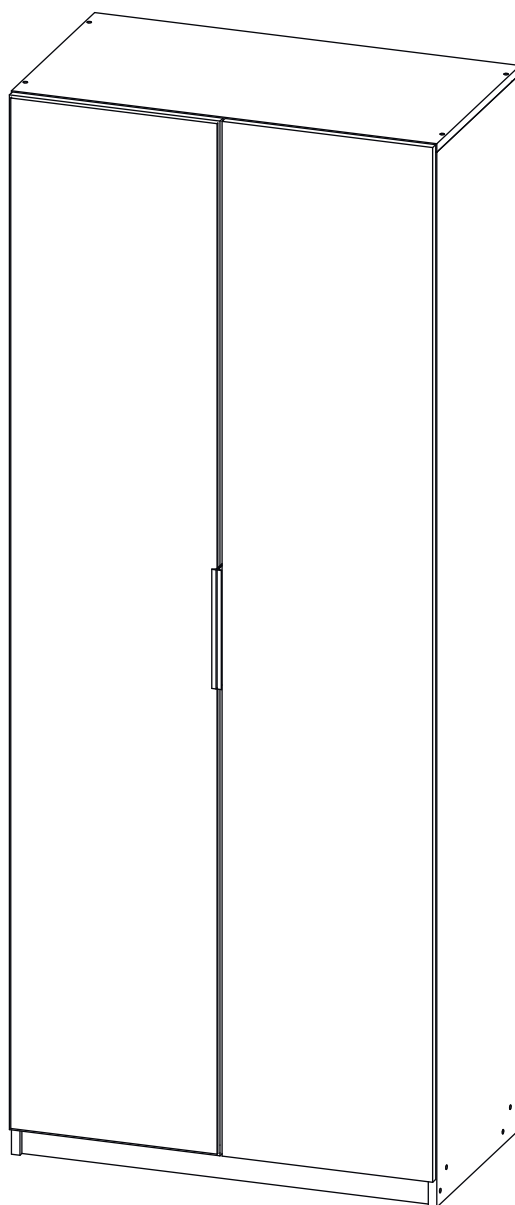



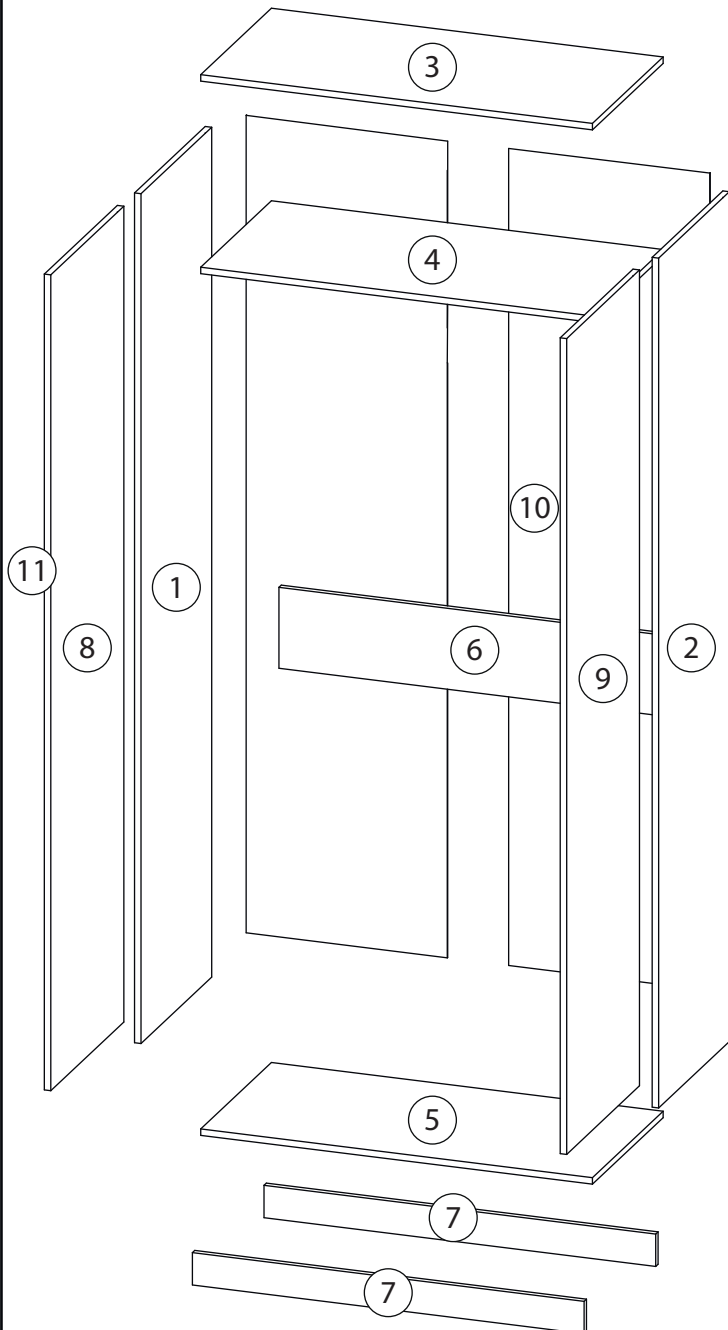

Детали

Поз.	Наименование	Кол-во	Длина	Ширина
1	Бок левый	1	2384	430
2	Бок правый	1	2384	430
3	Крыша	1	1200	480
4	Полка	1	1168	430
5	Дно	1	1168	430
6	Ребро жесткости	1	200	968
7	Цоколь	2	1168	50
8	Фасад 1	1	2346	596
9	Фасад 2	1	2346	596
10	Задняя стенка	2	2346	597
11	Зеркало	1	2338	588

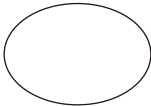
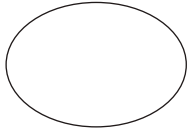

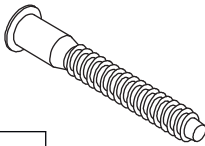
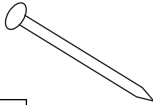
Фурнитура

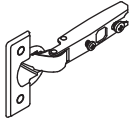
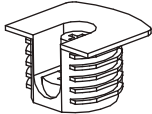
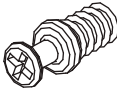
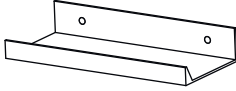
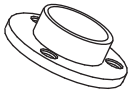
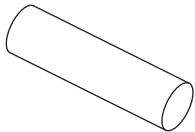
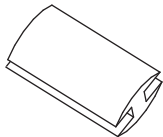
 12	 13	 14	 15	 16
<u>Заглушка</u> $\varnothing 13$	<u>Заглушка</u> $\varnothing 17-20$	<u>Евровинт 6,3x13</u>	<u>Евровинт 7x50</u>	<u>Гвоздь 1,6x25</u>
 17	 18	 19	 20	 21
<u>Саморез 3,5x16</u>	<u>Петля накладная</u>	<u>Стяжка VB35</u>	<u>Винт для стяжки</u> <u>VB35</u>	<u>Ручка</u>
 22	 23	 24		
<u>Штангодержатель</u>	<u>Штанга</u>	<u>Профиль для ДВП</u>		

1

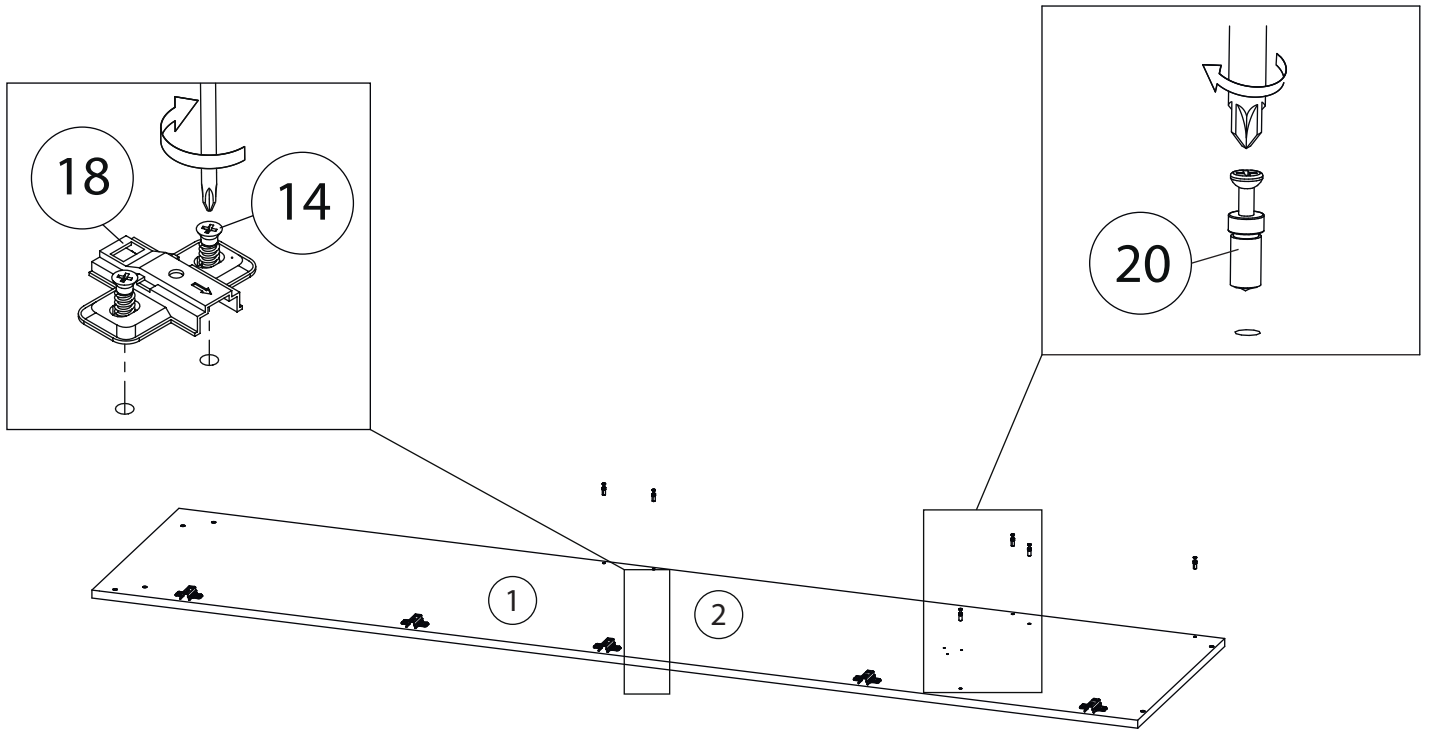

2

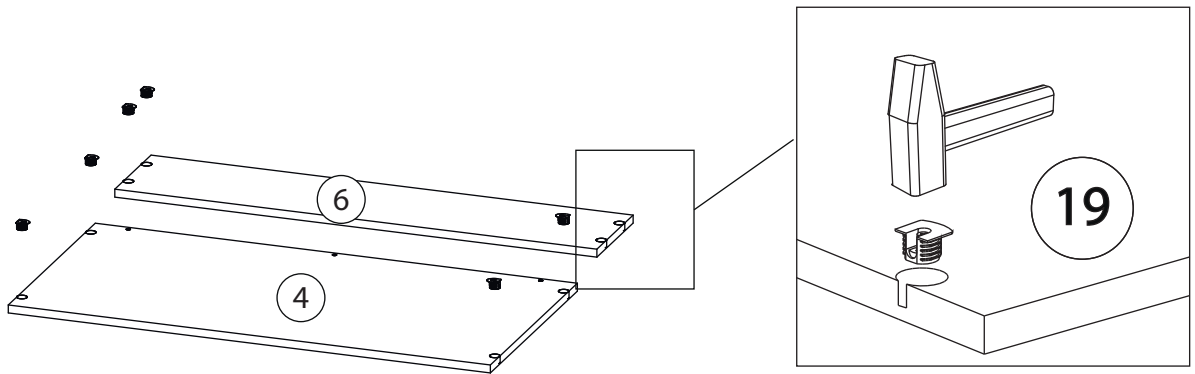

3

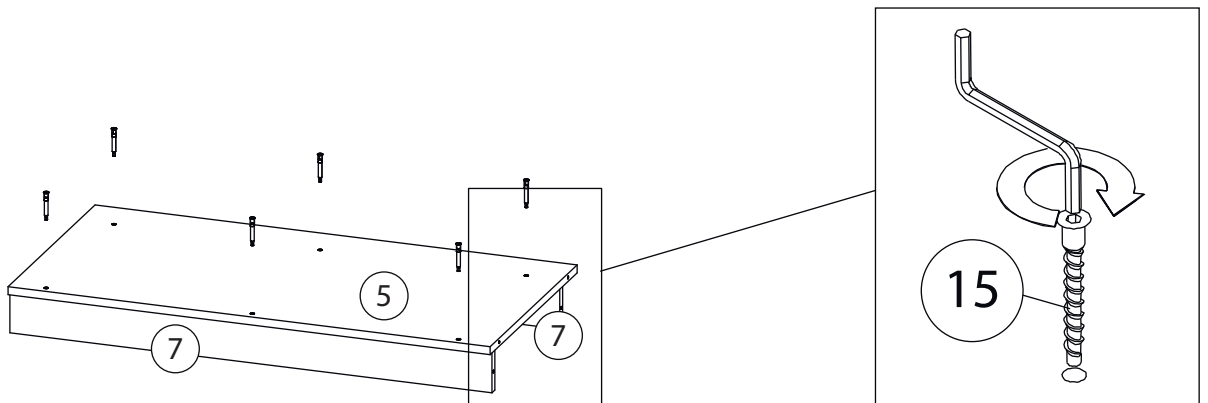

4

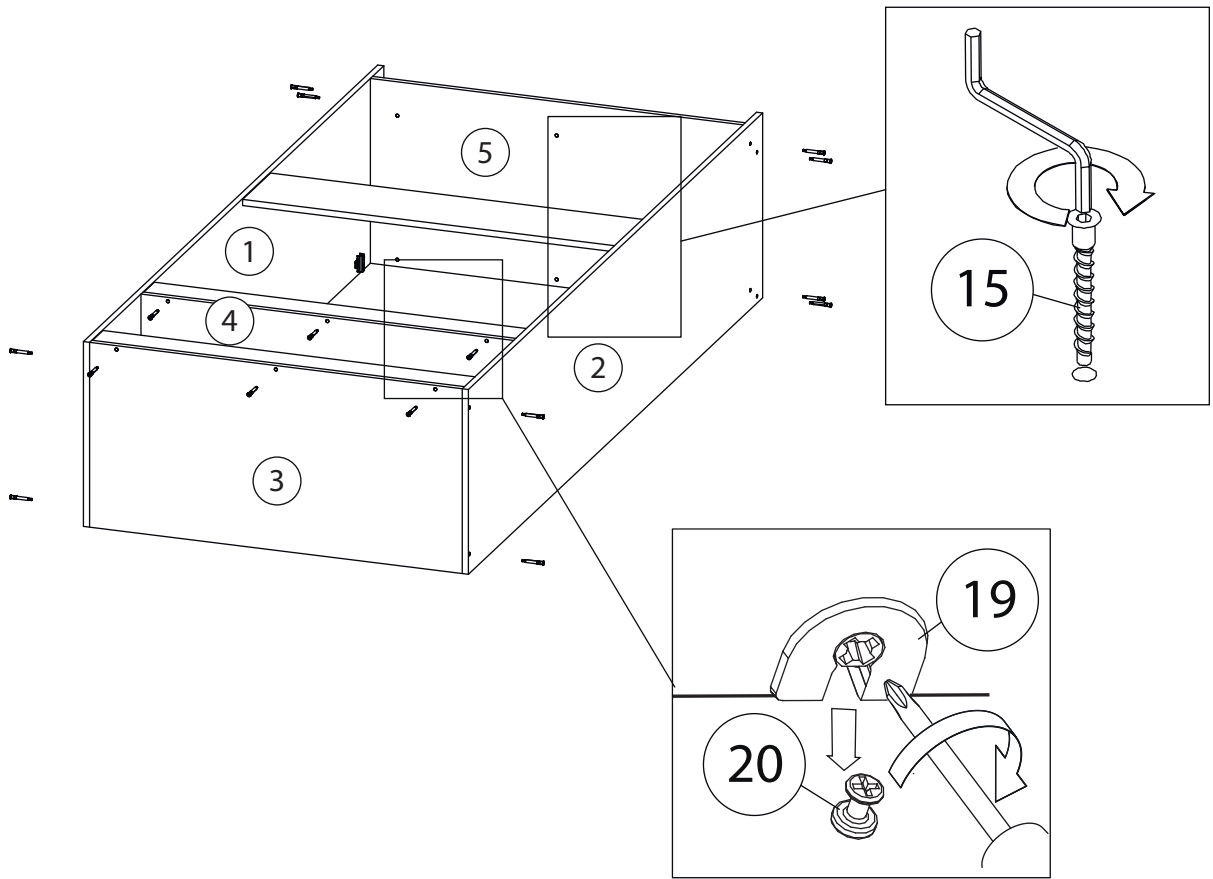

6

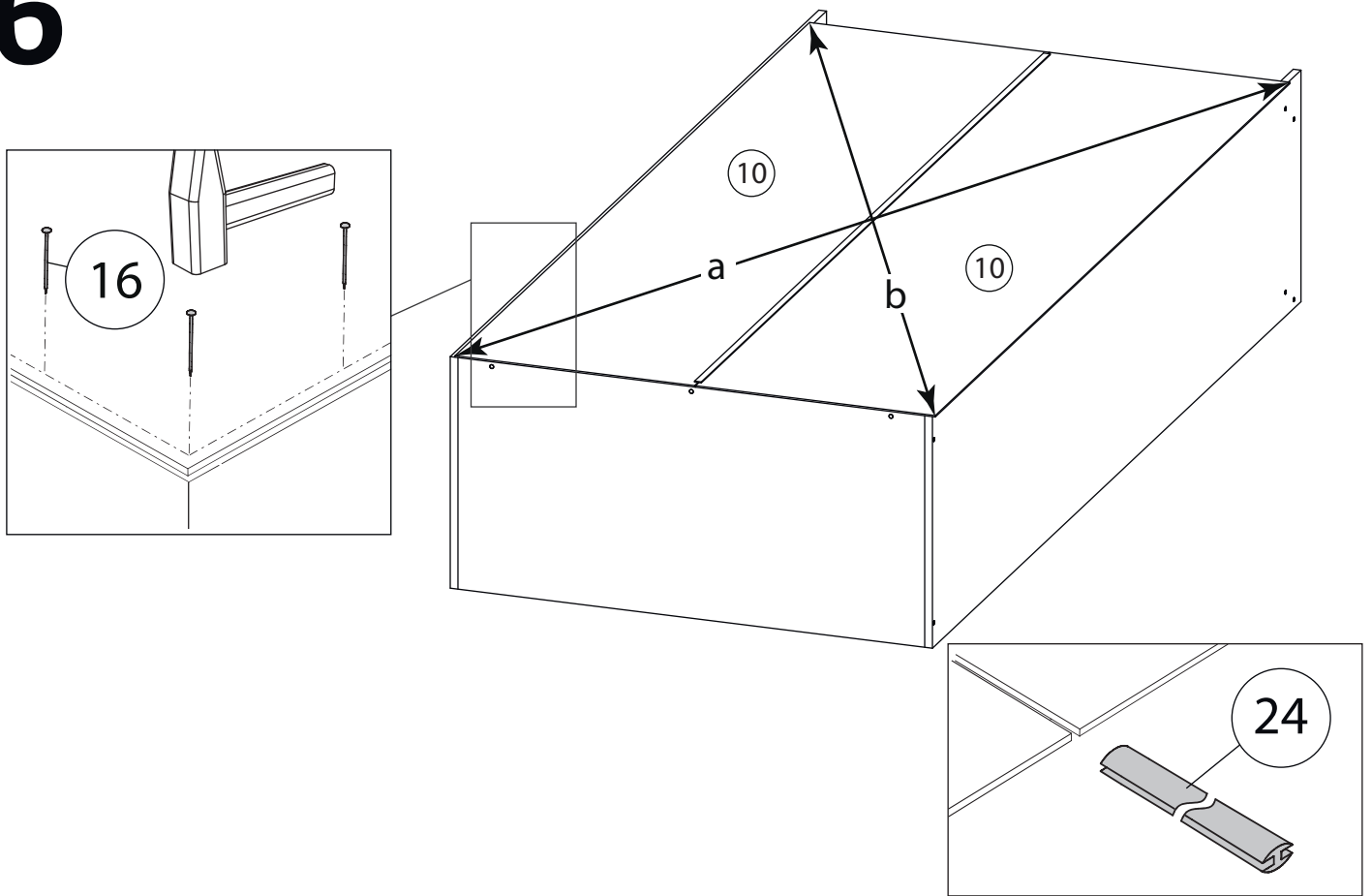

$$a=b$$

7

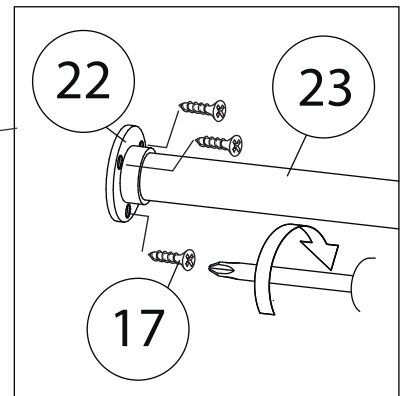
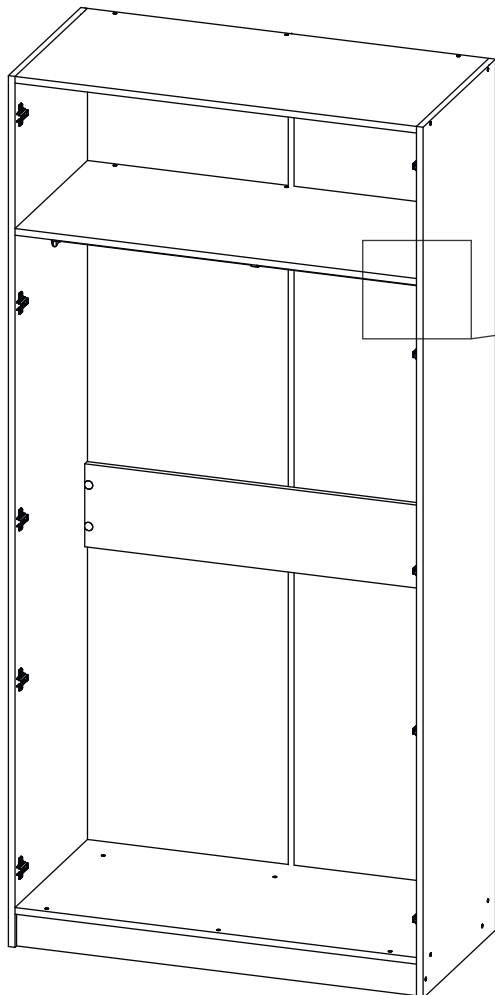
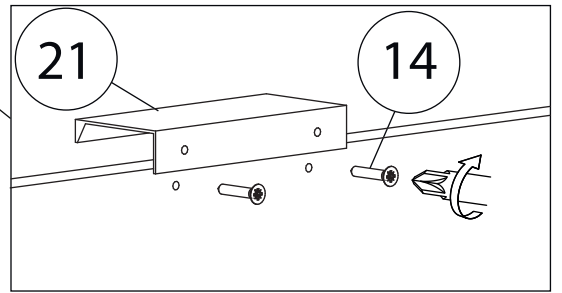
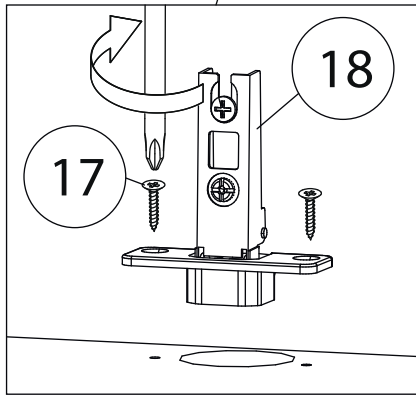
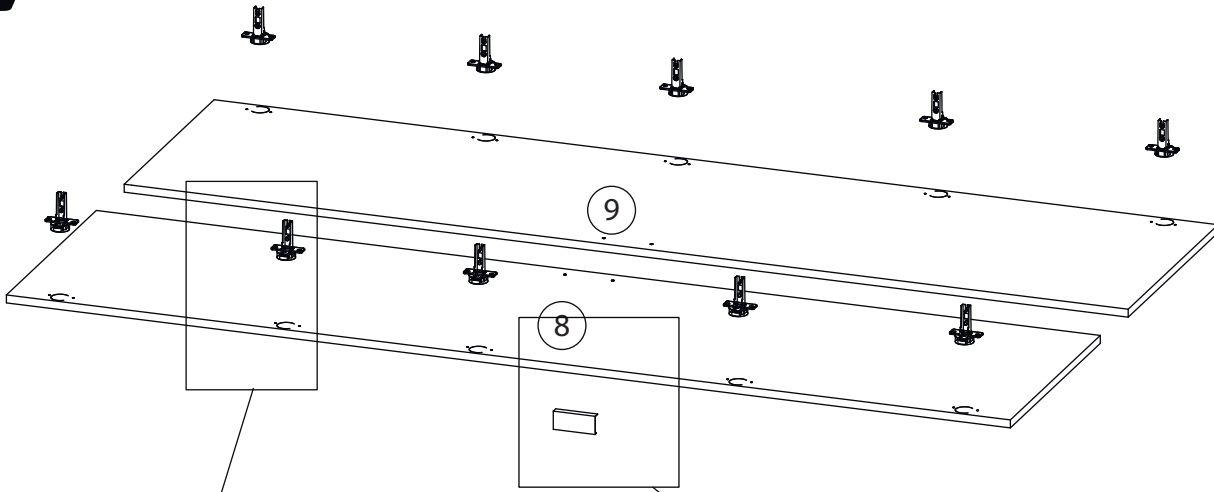

8

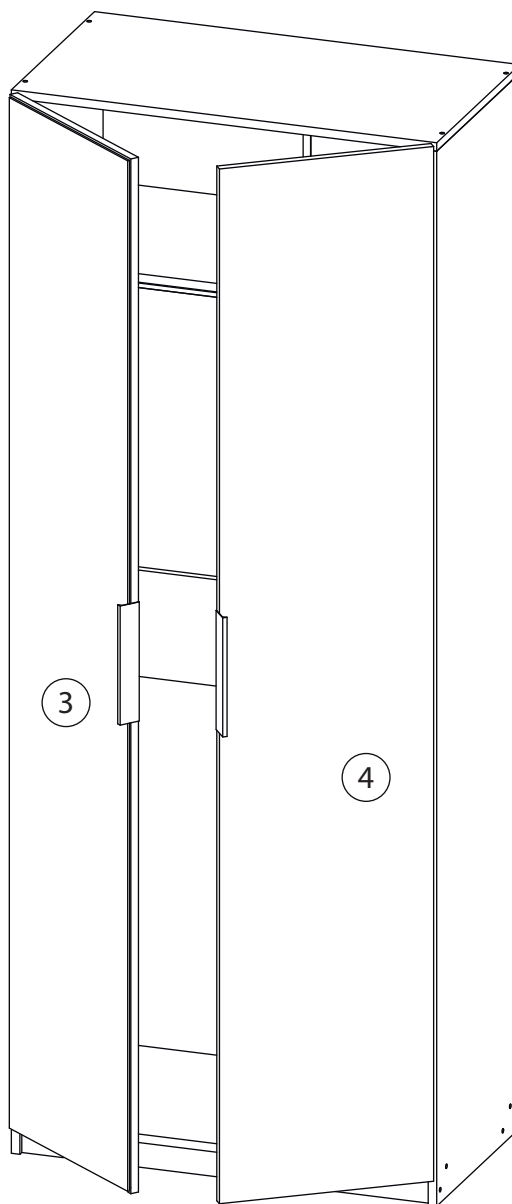

Заклеить технические отверстия заглушками.

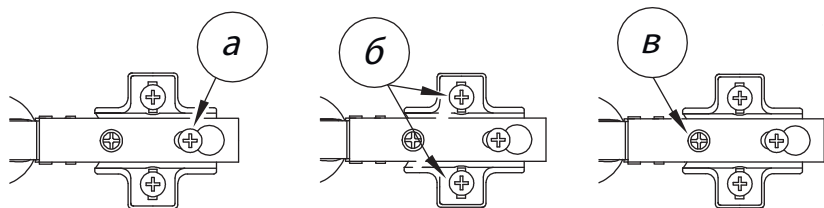

Регулировка петель

а - регулировка расстояния между дверью и корпусом
б - регулировка положения двери по-вертикали
в - регулировка положения ТТдвери по-горизонтالي